



EnergySand-Multibrush 120



KASUTUSJUHEND

(algse kasutusjuhendi tõlge)

Vahetatavate harjadega statsionaarne renoveerija

PEUGEOT OUTILLAGE

132320-A-20231214



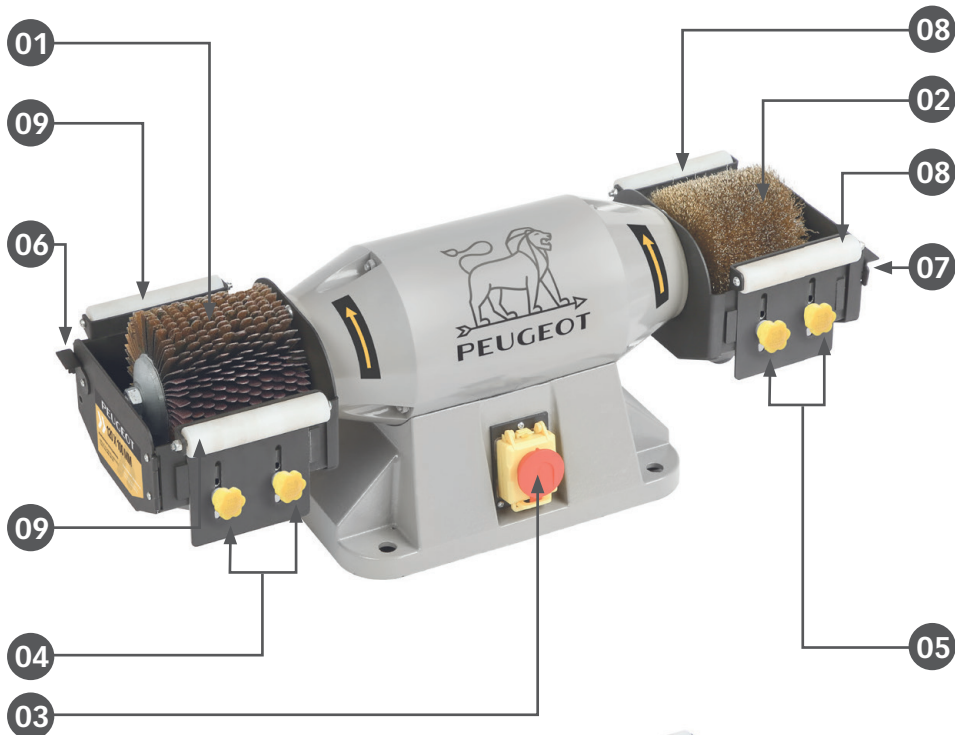



Fikseerige seade töölaual külge

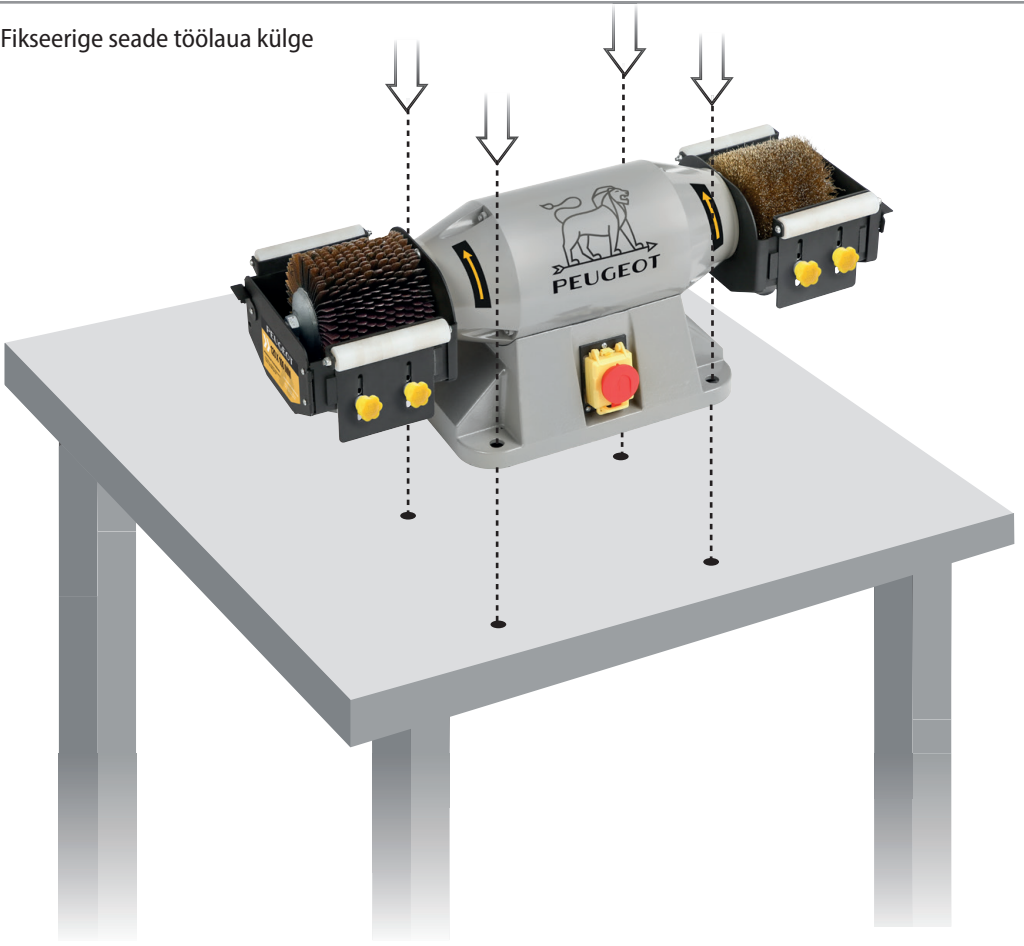

01

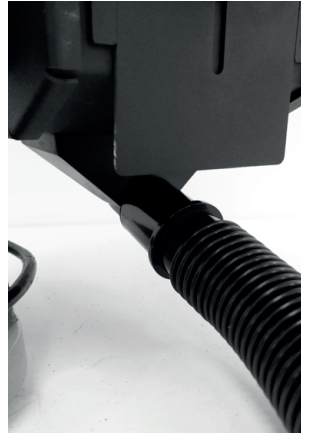
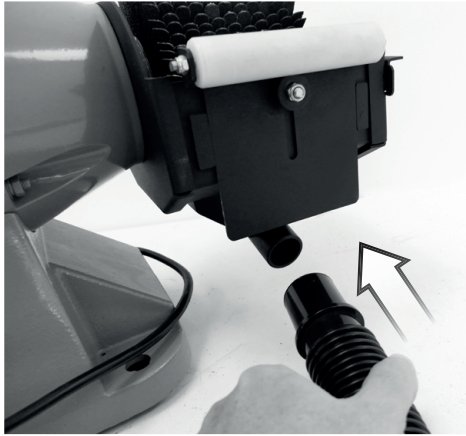

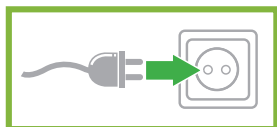

01

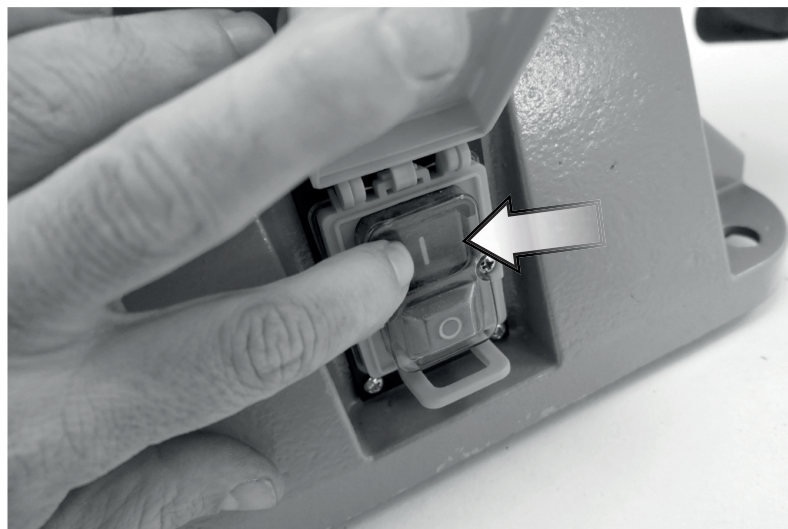

02

Häda-
seiskamine:
häda-
seiskamisnupp

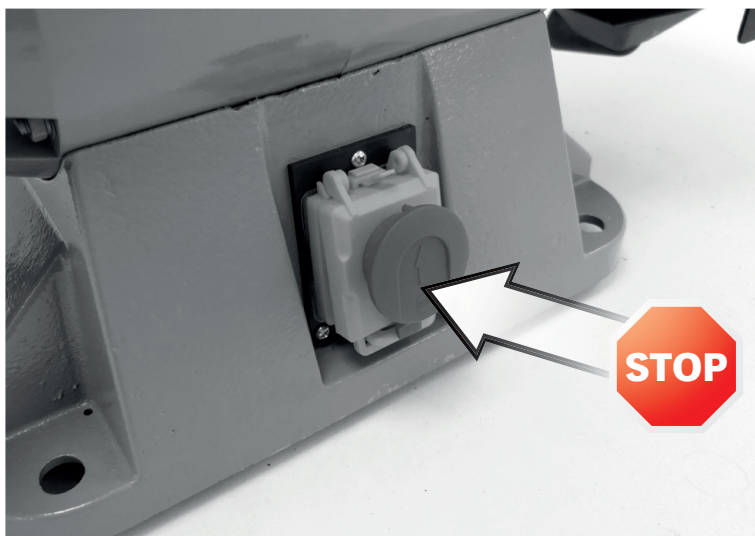

03 Töökõrguse kohandamine

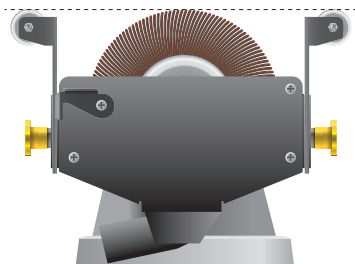
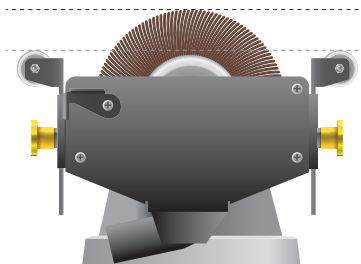
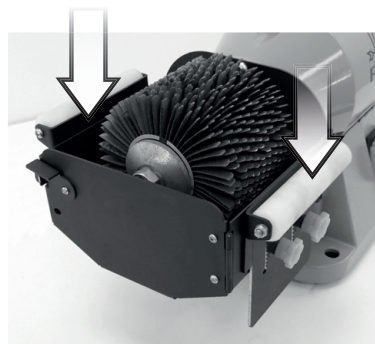
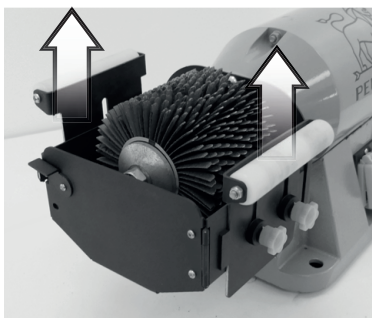
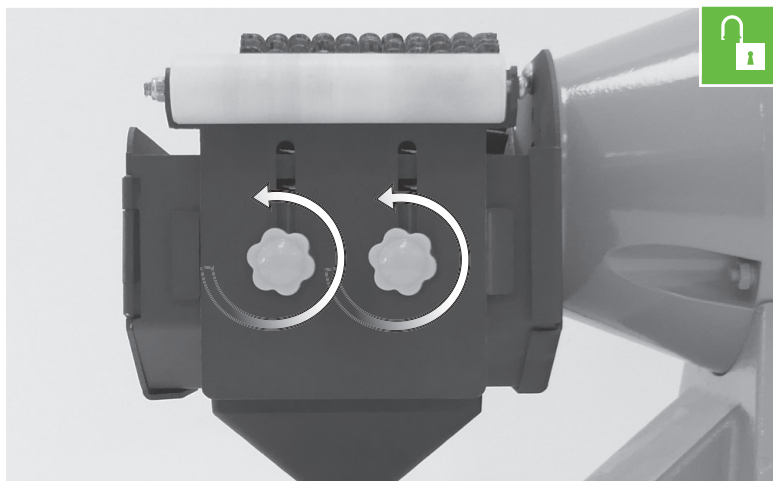

04 Ühendage seade tolmuimejaga



05

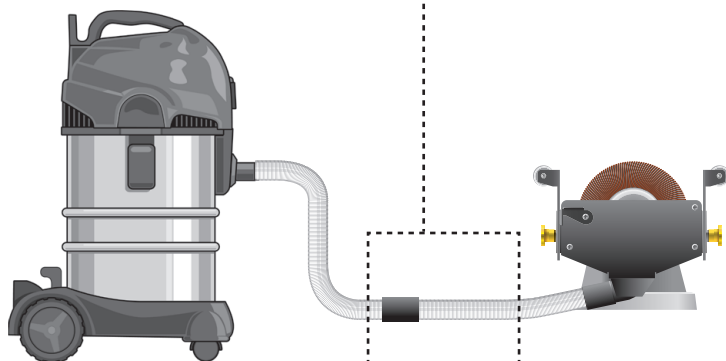

Parema imemise tagamiseks sulgege kasutamata imitoru kaasasoleva korkiga

12





06

Töötamise suund renoveeritavas ruumis

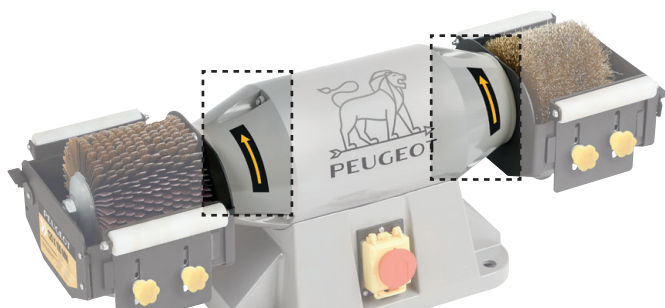
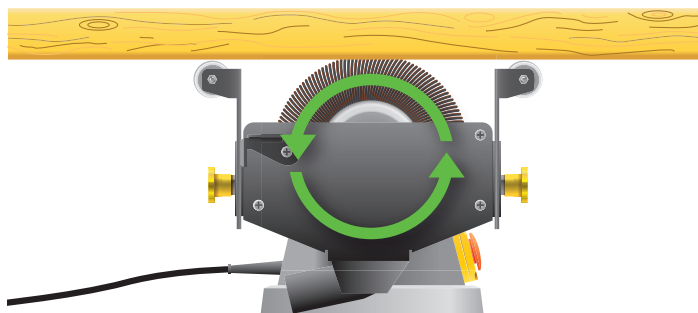

07

Harjade vahetamine

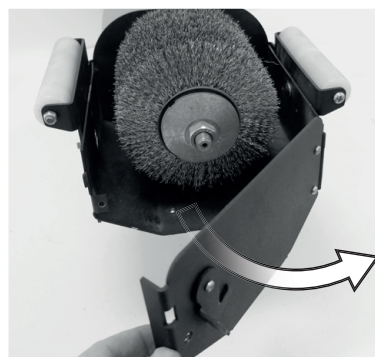
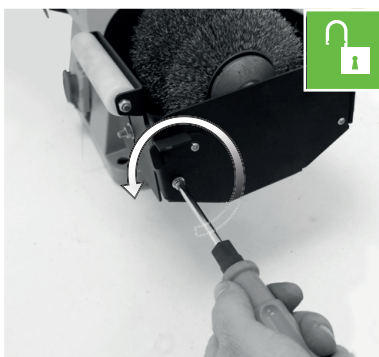
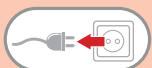

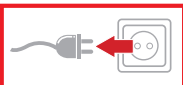

08



Enne mistahes
tööde alustamist
seadmel lahutage
see KINDLASTI
vooluvõrgust!

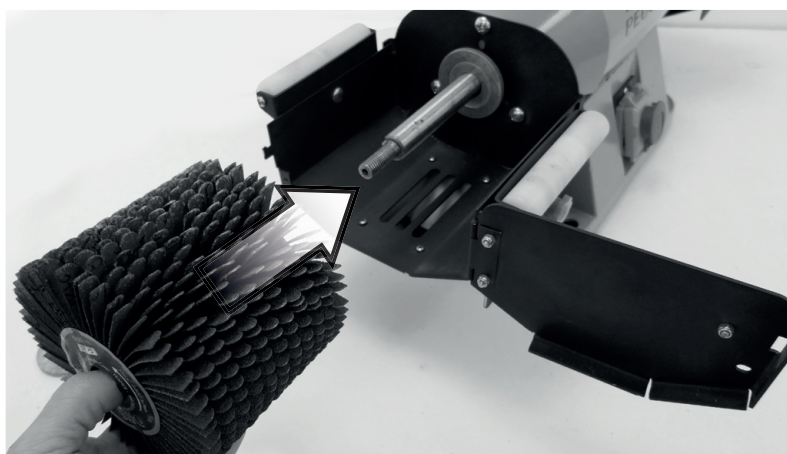
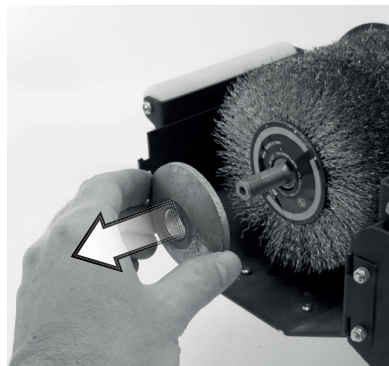
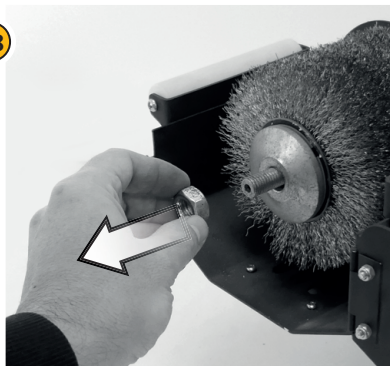

09

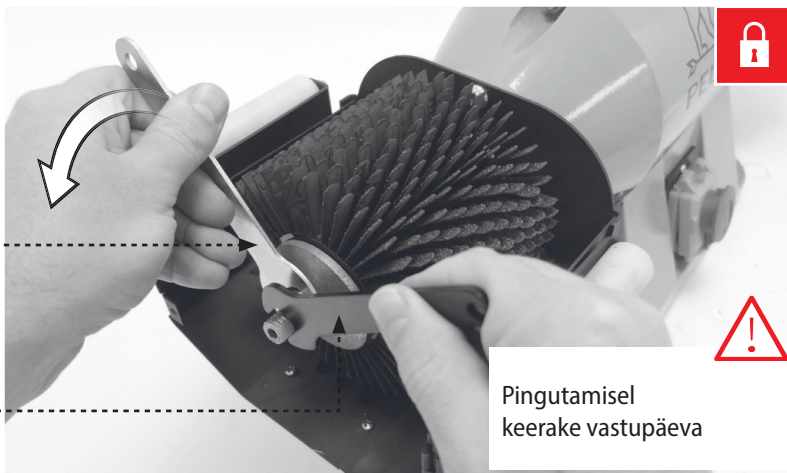
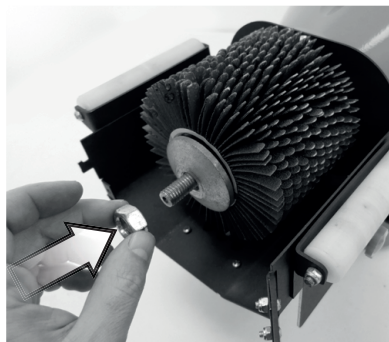
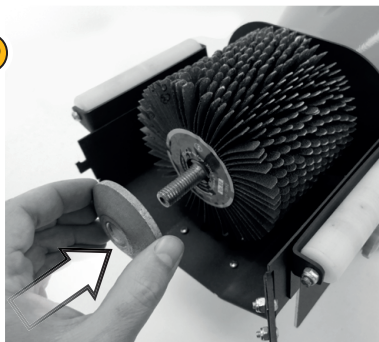

Pingutamisel
keerake vastupäeva



11



Koormisharjad ja abrasiivsed terad:
pöörake tähelepanu harja pöörlemissuunale





Valikvarustus

Rasvaemaldushari – kerge koorimine



800301

Puhastushari



800302

Tasaste pindade lihvimise hari



800303

Tasaste pindade lihvimise hari



800304

Lamellhari kumerate pindade lihvimiseks



800305

Lamellhari kumerate pindade lihvimiseks



800306



Valikvarustus

PEUGEOT' lihvketaste hoidik

100511





- 01 Tähelepanu! Kui töötate ühe harjaga, pöörake tähelepanu vastaspoolele olevale harjale, mis pöörleb selle kõrval samal kiirusel.

Olge kogu aeg ettevaatlik!

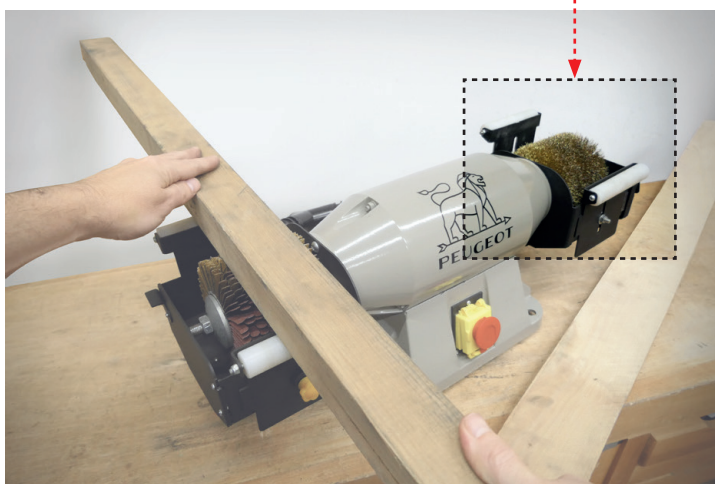





EnergySand-Multibrush120
132320
PM-20HD

Vahetatavate harjadega
statsionaarne renoveerija

	Nimisagedus ja võimsus:	230 V ~ 50 Hz
---	-------------------------	---------------

	Nimivõimsus:	S6 LÜHIAJALINE REŽIIM <small>Too pideval koormusel kindla alajärelmiku jooksul, mis on lühem kui temperatuuri tasakaalustumise aeg, millele järgneb pikaväi paus, et taastada mootori ja ahutusõhu temperatuuri võrdus. MÄRKUS: see režiim võib võimaldada nimivõimsusest suuremat väljundvõimsust.</small>	900 W (S6 : 15%)
--	--------------	---	------------------

	Koormuseta kiirus:	2980 min ⁻¹
--	--------------------	------------------------

	Ketta läbimõõt ja laius:	120 x 100 mm
--	--------------------------	--------------

	Kasutamiseks ainult siseruumides	X
--	----------------------------------	---

IP 44		X
--------------	--	---

	Enne kasutamist lugege kasutusjuhendit:	X
---	---	---

	Kandke kaitseprille:	X
---	----------------------	---

	Kandke tolumumaski:	X
---	---------------------	---

	Kandke kuulmiskaitsevahendeid:	X
---	--------------------------------	---

	Kandke kindaid:	X
---	-----------------	---

	Vastab EÜ standarditele:	X
---	--------------------------	---

	Oht:	X
---	------	---

	Kaal:	22 kg
--	-------	-------

	Ringlussevõetav, tuleb võtta ringlusse:	x
--	---	---

	Tuleb võtta ringlusse:	x
--	------------------------	---

Jäätmete ringlussevõtt

Tööriistad, lisatarvikud ja nende pakendid tuleb nõuetekohaselt ringlusse võtta. Euroopa direktiivide 2012/19/EL ja 2006/66/EÜ kohaselt tuleb toote osad eraldada, koguda, ringlusse võtta või kõrvaldada kooskõlas kehtivate keskkonnanäeskirjadega. Seadmed, akud, patareid, õlid ja pakendid tuleb kõrvaldada spetsiaalse jäätmete kõrvaldamise süsteemi (näiteks jäätmetöötluskeskus) kaudu. Uurige kohalikult omavalitsusest, kus asub lähim asutus, mis töötab selliseid jäätmeid ümber või võtab vastu.

 L_pA	Mürasurve tase:	84,2 dB (A)
--	-----------------	-------------

 L_{wA}	Helivõimsuse tase:	97,2 dB (A)
--	--------------------	-------------

MÜRATASE:

KOORMUSETA

Helirõhutase L _{pA} operaatori töökohal	84,2 dB
Möötemääramatus	3
Helivõimsuse tase L _{wA}	97,2 dB
Möötemääramatus	3

Väärtused on kindlaks määratud standardi EN 62841-1 lisa B katsekoodi kohaselt, kasutades põhistandardeid ISO 11201 ja ISO 3744.

Kohapeal saadud helirõhutase on:

- asjaomase masina tegelikust tasemest, võttes arvesse esitatud möötemääramatusi;
- masina asukohast ja paigaldusest. Eelistage ruumi, mille akustikat saab summutada. Vältige suure resonantsiga tühje ruume. Vajaduse korral tehke tööd akna lähedal.
- Ühendatud tööriistad, töödeldavad osad, valitud seaded jne.

TEAVE

- Esitatud vibratsiooni koguväärtus(ed) ja mürataseme väärtus(ed) on mõõdetud standardse katsemeetodi kohaselt ning neid saab kasutada tööriistade võrdlemiseks.
- Esitatud vibratsiooni koguväärtust (-väärtusi) ja mürataseme väärtust (väärtusi) võib kasutada ka kokkupuute esialgseks hindamiseks.

HOIATUS!

- Vibratsiooni- ja mürataseme mootortööriista kasutamisel võib esitatud väärtustest erineda olenevalt tööriista kasutamise viisist, eelkõige töödeldava detaili tüübist.
- Operaatori kaitsmiseks tuleb võtta ohutusmeetmed, mis põhinevad kokkupuute hindamisel tegelikes kasutustingimustes (võttes arvesse käitamistsükli kõiki osi, näiteks neid, kui tööriist on välja lülitatud või töötab koormuseta ning kui hooba liigutatakse).

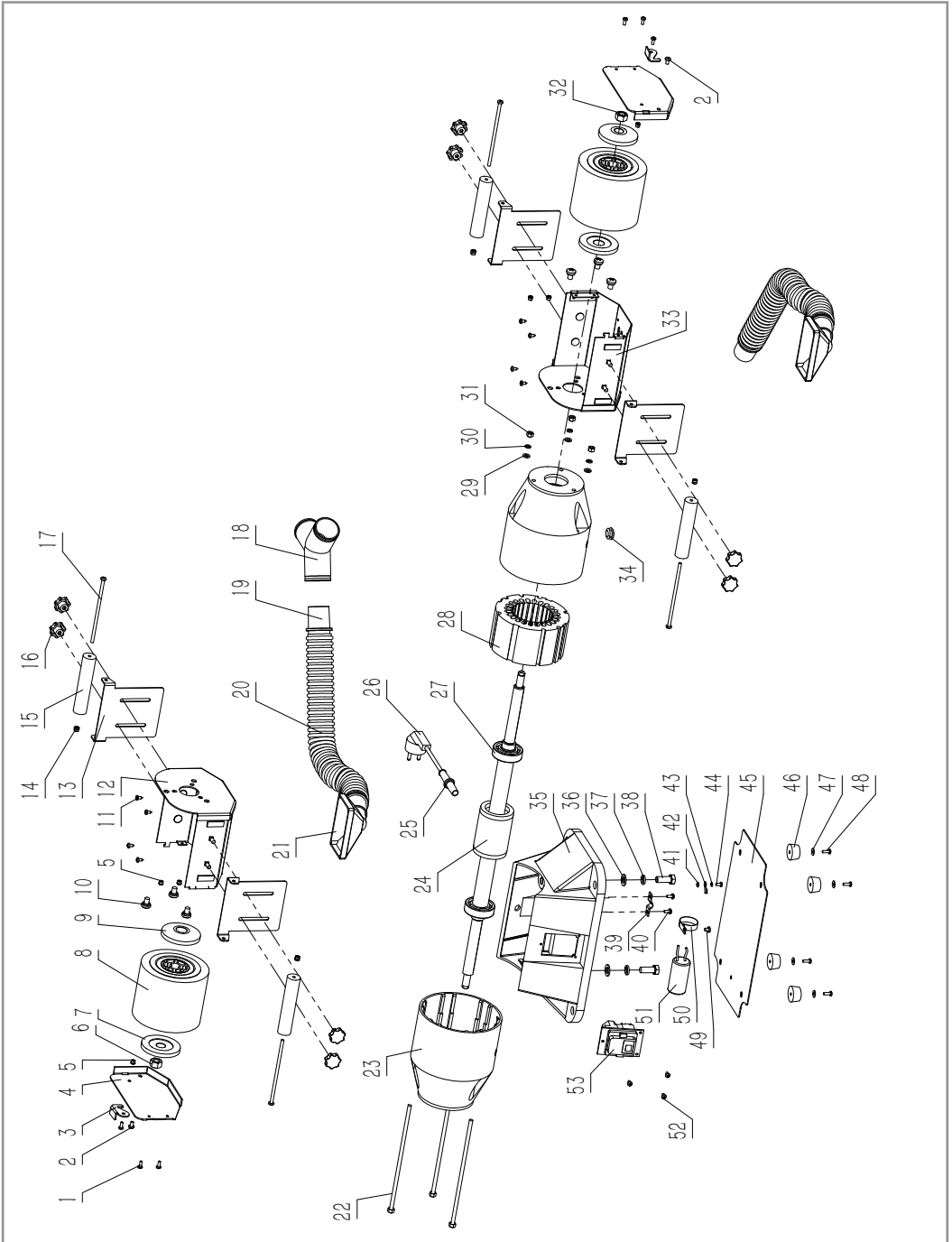

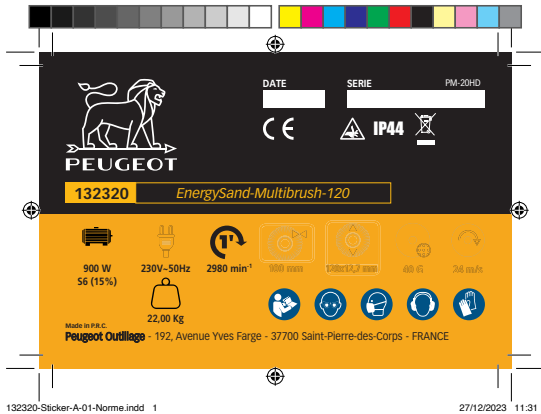

132320-Sticker-A-01-Norme.indd 1

27/12/2023 11:31



132320-Sticker-A-02-Carter Brosse lanières.indd 1

18/12/2023 09:31

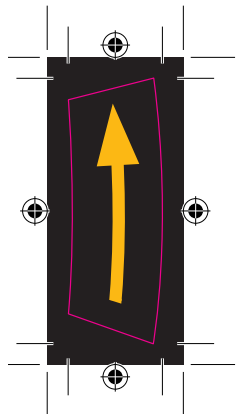

132320-Sticker-A-03-Carter Brosse laitonn.indd 1

18/12/2023 09:31

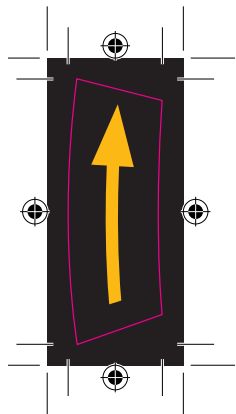



CE-VASTAVUSDEKLARATSIOON

Allakirjutanu

PEUGEOT OUTILLAGE

192, Avenue Yves Farge – 37700 St. Pierre-des-Corps – PRANTSUSMAA
Tel 02 3616 7146 - Faks 02 3616 7140

kinnitab, et

KOOD

PEUGEOT / EnergySand-multibrush-120 / 132320 / PM-20HD

vahetatavate harjadega statsionaarne renoveeriija

vastab EMÜ standarditele:

2006/42/EC 2014/30/EU 2000/14/EC&2005/88/EC

EN 62841-1:2015/A11:2022
EN 62841-3-4:2016/A12:2020
EN IEC 55014-1:2021
EN IEC 55014-2:2021
EN IEC 61000-3-2:2019+A1:2021
EN 61000-3-3:2013/A2:2021

Tehnilist faili
koostama volitatud isik:
Christophe HUREL



SIGMA
PEUGEOT OUTILLAGE'1 president
Esindab president:
Christophe HUREL
14.12.2023
Koostatud: St. Pierre-des-Corps



GARANTII

1. Garantii ulatus

Garantii kehtib ainult tootmis- või materjalidefektide korral.

Oleme kohustatud vahetama või parandama osad, mis on tunnistanud kasutuskõlbatuks.

2. Garantii

Garantii kehtib 36 kuud alates seadme kasutajale üleandmise kuupäevast (tuleb esitada arve või kviitung).

Garantii alusel toimunud osade vahetamine või parandamine ei pikenda algset garantiiaega.

Kasutaja vastutab algsete saatekulude eest.

3. Reservatsioonid

Garantii ei hõlma volitamata remonditöökoja tehtud parandustöid.

Seadet ei tohi garantiiaja jooksul mingil juhul lahti võtta.

Ostukuupäev	Seadme kood	Edasimüüja tempel

MÜÜGIJÄRGNE HOOLDUS

PEUGEOT OUTILLAGE – 192, Avenue Yves Farge – 37700 St. Pierre-des-Corps – PRANTSUSMAA – Tel 02 3616 7146 Faks 02 3616 7140



PEUGEOT OUTILLAGE

Kontserni SIGMA ettevõte **SIGMA**

192, Avenue Yves Farge
37700 St. Pierre-des-Corps
PRANTSUSMAA

peugeot-outillage.com

