

INSTALLATION MANUAL

MONTERINGSANVISNING
MONTERINGSANVISNING
MONTERINGSVEJLEDNING
ASENNUSOHJE

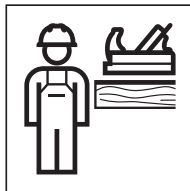

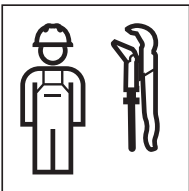

WARNUNG

Unsachgemäße Montage

Herabfallen des Produkts kann zu schweren Verletzungen führen.

- ▶ Vor der Montage die Tragfähigkeit der Wand prüfen.
- ▶ Vor der Montage prüfen, ob das mitgelieferte Befestigungsmaterial für den Wandtyp geeignet ist. Das Befestigungsmaterial bei Bedarf austauschen.



WARNING

Incorrect installation

If the product falls, it can cause serious injuries.

- ▶ Before installation, check the bearing capacity of the wall.
- ▶ Before installation, check whether the fastening material supplied is suitable for the wall type. Use a different type of fastening material if necessary.



ADVARSEL

Uhensigtsmæssig montering

Hvis produktet falder ned, kan det føre til alvorlige kvæstelser.

- ▶ Kontroller væggens bæreevne inden monteringen.
- ▶ Kontroller inden monteringen, om det medfølgende fastgørelsesmateriale er egnet til vægtypen. Udskift fastgørelsesmaterialet ved behov.



ADVARSEL

Ufagmessig montering

Hvis produktet falder ned, kan det føre til alvorlige personskader.

- ▶ Kontroller bæreevnen til væggen før monteringen.
- ▶ Kontroller før monteringen om det medfølgende fastematerialet egner sig for vægtypen. Byt festemateriale ved behov.



VARNING

Felaktig montering

Om produkten faller ned kan den orsaka allvarliga personskador.

- ▶ Kontrollera väggens bärförmåga före monteringen.
- ▶ Kontrollera före monteringen om det medföljande infästningsmaterialet lämpar sig för väggtypen. Byt ut infästningsmaterialet vid behov.



VAROITUS

Epäasianmukainen asennus

Tuotteen putoaminen voi aiheuttaa vakavia vammoja.

- ▶ Tarkasta ennen asennusta seinän kantavuus.
- ▶ Tarkasta ennen asennusta, soveltuuko mukana toimitettu kiinnitysmateriaali seinätyyppiin. Vaihda kiinnitysmateriaali tarvittaessa.



HOIATUS

Asjatundmatu montaaž

Toote allakukkumine võib põhjustada raskeid vigastusi.

- ▶ Kontrollige enne montaaži seina kandevõimet.
- ▶ Kontrollige enne montaaži, kas kaasasolev kinnitusmaterjal sobib seinatüübi jaoks. Vajaduse korral vahetage kinnitusmaterjal välja.



BRĪDINĀJUMS

Nelietpratīga montāža

Produkta nokrišana var izraisīt smagas traumas.

- ▶ Pirms montāžas pārbaudiet sienas nestspēju.
- ▶ Pirms montāžas pārbaudiet, vai piegādes komplektā iekļautais stiprinājuma materiāls ir piemērots sienas tipam. Stiprinājuma materiālu nepieciešamības gadījumā nomainiet.



ĪSPĒJIMAS

Netinkamas montavimas

Produkto nukritimas gali sukelti sunkių sužalojimų.

- ▶ Prieš montuodami patikrinkite sienos patvarumą.
- ▶ Prieš montuodami patikrinkite, ar kartu pateikta tvirtinimo priemonė tinka tokiam sienos tipui. Prireikus tvirtinimo priemonę pakeiskite.

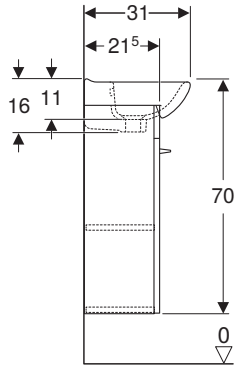
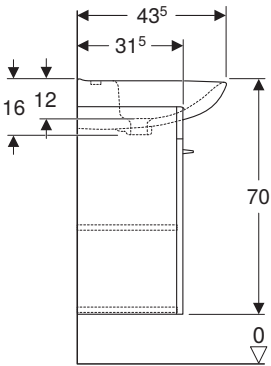
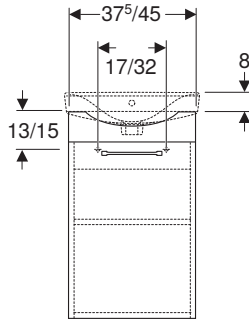
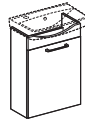
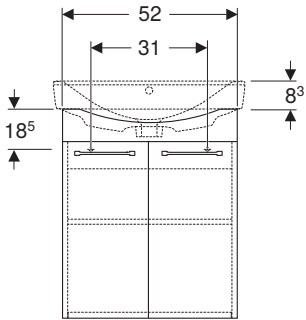

i

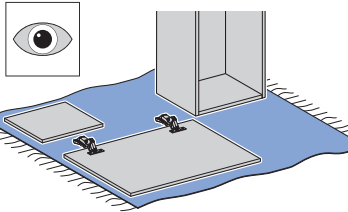

1

1

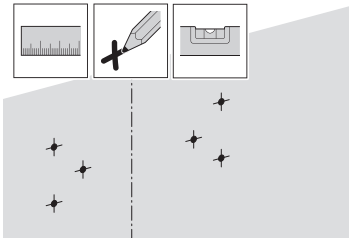

i



EN 15651-3: Class XS1

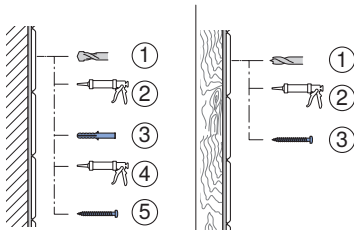

2

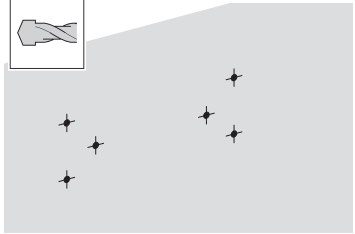

3

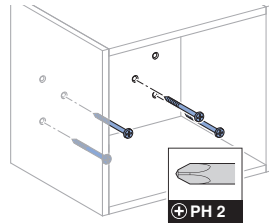

2

1

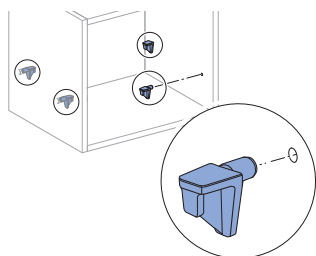

2

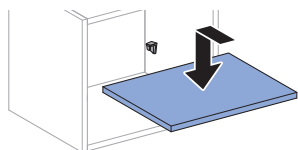

3

1

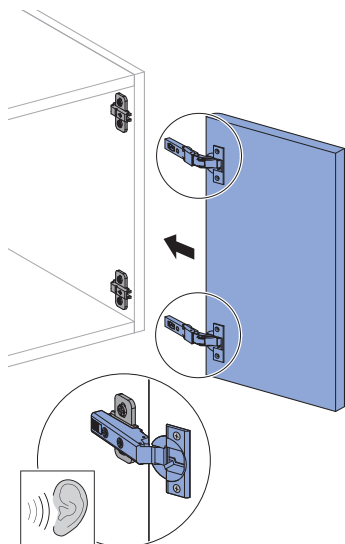

2

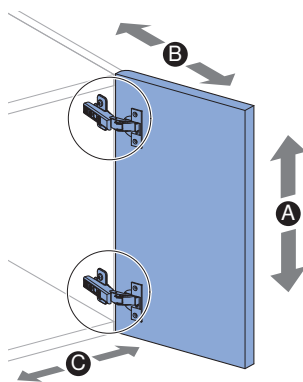
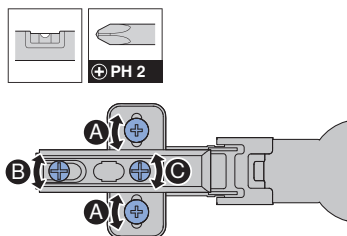

4

i

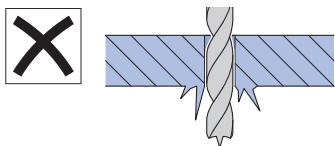
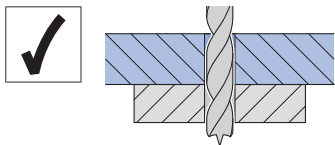

1

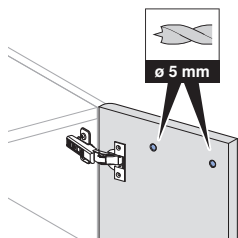

2

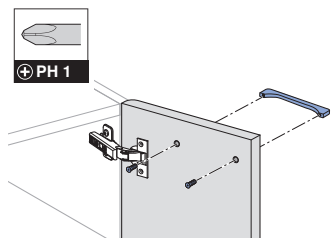

5

i



1

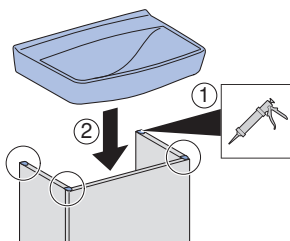

2

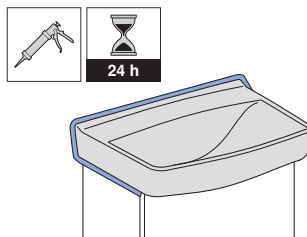

Geberit International AG
Schachenstrasse 77, CH-8645 Jona
documentation@geberit.com
www.geberit.com

